

MMBT5087LT1G

Low Noise Transistor

PNP Silicon

Features

- These Devices are Pb-Free, Halogen Free/BFR Free and are RoHS Compliant

MAXIMUM RATINGS

Rating	Symbol	Value	Unit
Collector - Emitter Voltage	V_{CEO}	-50	Vdc
Collector - Base Voltage	V_{CBO}	-50	Vdc
Emitter - Base Voltage	V_{EBO}	-3.0	Vdc
Collector Current - Continuous	I_C	-50	mAdc

THERMAL CHARACTERISTICS

Characteristic	Symbol	Max	Unit
Total Device Dissipation FR-5 Board, (Note 1) $T_A = 25^\circ\text{C}$ Derate above 25°C	P_D	225 1.8	mW mW/ $^\circ\text{C}$
Thermal Resistance, Junction-to-Ambient	$R_{\theta JA}$	556	$^\circ\text{C}/\text{W}$
Total Device Dissipation Alumina Substrate, (Note 2) $T_A = 25^\circ\text{C}$ Derate above 25°C	P_D	300 2.4	mW mW/ $^\circ\text{C}$
Thermal Resistance, Junction-to-Ambient	$R_{\theta JA}$	417	$^\circ\text{C}/\text{W}$
Junction and Storage Temperature	T_J, T_{stg}	-55 to +150	$^\circ\text{C}$

Stresses exceeding Maximum Ratings may damage the device. Maximum Ratings are stress ratings only. Functional operation above the Recommended Operating Conditions is not implied. Extended exposure to stresses above the Recommended Operating Conditions may affect device reliability.

1. FR-5 = $1.0 \times 0.75 \times 0.062$ in.
2. Alumina = $0.4 \times 0.3 \times 0.024$ in. 99.5% alumina.



ON Semiconductor®

<http://onsemi.com>

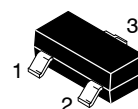
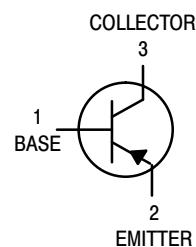

SOT-23 (TO-236)
CASE 318
STYLE 6

MARKING DIAGRAM

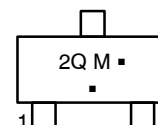

2Q = Device Code
M = Date Code*
■ = Pb-Free Package

(Note: Microdot may be in either location)

*Date Code orientation and/or overbar may vary depending upon manufacturing location.

ORDERING INFORMATION

Device	Package	Shipping†
MMBT5087LT1G	SOT-23 (Pb-Free)	3,000 / Tape & Reel
MMBT5087LT3G	SOT-23 (Pb-Free)	10,000/Tape & Reel

†For information on tape and reel specifications, including part orientation and tape sizes, please refer to our Tape and Reel Packaging Specifications Brochure, BRD8011/D.

MMBT5087LT1G

ELECTRICAL CHARACTERISTICS (T_A = 25°C unless otherwise noted)

Characteristic	Symbol	Min	Max	Unit
OFF CHARACTERISTICS				
Collector-Emitter Breakdown Voltage (I _C = -1.0 mA, I _B = 0)	V _{(BR)CEO}	-50	-	Vdc
Collector-Base Breakdown Voltage (I _C = -100 μA, I _E = 0)	V _{(BR)CBO}	-50	-	Vdc
Collector Cutoff Current (V _{CB} = -10 Vdc, I _E = 0) (V _{CB} = -35 Vdc, I _E = 0)	I _{CBO}	-	-10 -50	nAdc
ON CHARACTERISTICS				
DC Current Gain (I _C = -100 μA, V _{CE} = -5.0 Vdc) (I _C = -1.0 mA, V _{CE} = -5.0 Vdc) (I _C = -10 mA, V _{CE} = -5.0 Vdc)	h _{FE}	250 250 250	800 - -	-
Collector-Emitter Saturation Voltage (I _C = -10 mA, I _B = -1.0 mA)	V _{CE(sat)}	-	-0.3	Vdc
Base-Emitter Saturation Voltage (I _C = -10 mA, I _B = -1.0 mA)	V _{BE(sat)}	-	0.85	Vdc
SMALL-SIGNAL CHARACTERISTICS				
Current-Gain — Bandwidth Product (I _C = -500 μA, V _{CE} = -5.0 Vdc, f = 20 MHz)	f _T	40	-	MHz
Output Capacitance (V _{CB} = -5.0 Vdc, I _E = 0, f = 1.0 MHz)	C _{obo}	-	4.0	pF
Small-Signal Current Gain (I _C = -1.0 mA, V _{CE} = -5.0 Vdc, f = 1.0 kHz)	h _{fe}	250	900	-
Noise Figure (I _C = -20 mA, V _{CE} = -5.0 Vdc, R _S = 10 kΩ, f = 1.0 kHz) (I _C = -100 μA, V _{CE} = -5.0 Vdc, R _S = 3.0 kΩ, f = 1.0 kHz)	NF	-	2.0 2.0	dB

TYPICAL NOISE CHARACTERISTICS

(V_{CE} = -5.0 Vdc, T_A = 25°C)

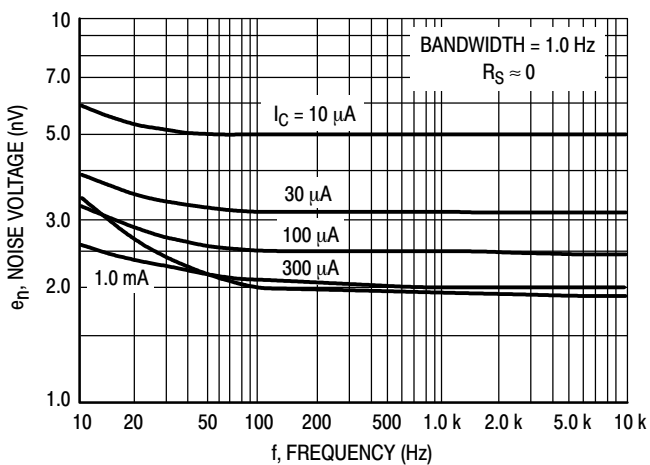

Figure 1. Noise Voltage

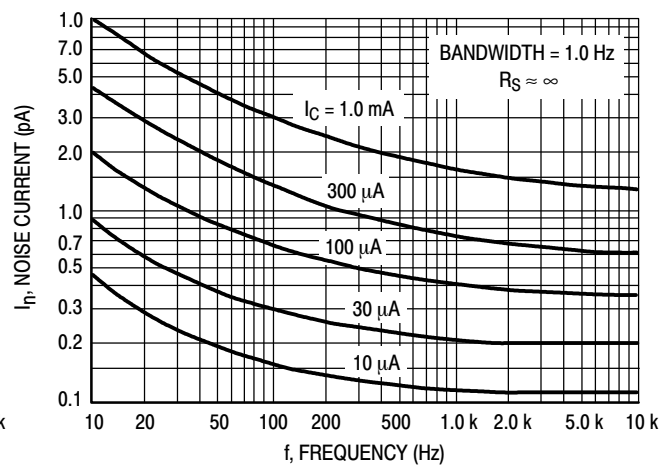

Figure 2. Noise Current

MMBT5087LT1G

NOISE FIGURE CONTOURS

($V_{CE} = -5.0 \text{ Vdc}$, $T_A = 25^\circ\text{C}$)

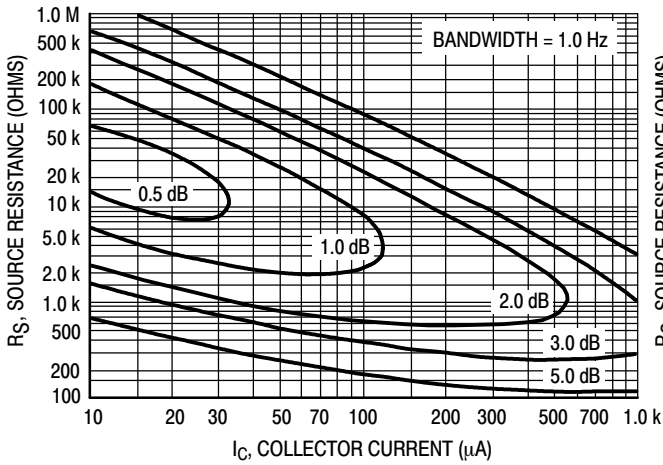

Figure 3. Narrow Band, 100 Hz

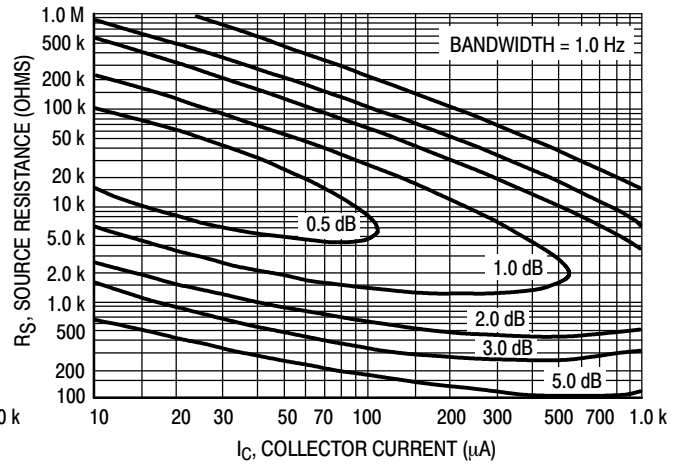

Figure 4. Narrow Band, 1.0 kHz

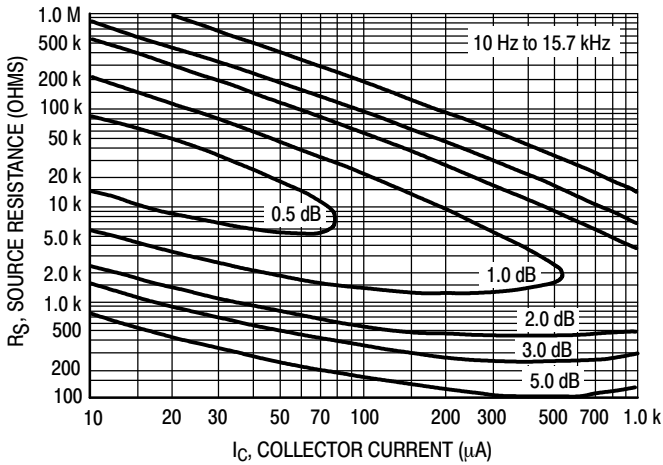

Figure 5. Wideband

Noise Figure is Defined as:

$$NF = 20 \log_{10} \left[\frac{e_n^2 + 4KTRS + I_n^2 R_S^2}{4KTRS} \right]^{1/2}$$

e_n = Noise Voltage of the Transistor referred to the input. (Figure 3)

I_n = Noise Current of the Transistor referred to the input. (Figure 4)

K = Boltzman's Constant ($1.38 \times 10^{-23} \text{ J/}^\circ\text{K}$)

T = Temperature of the Source Resistance ($^\circ\text{K}$)

R_S = Source Resistance (Ohms)

MMBT5087LT1G

TYPICAL STATIC CHARACTERISTICS

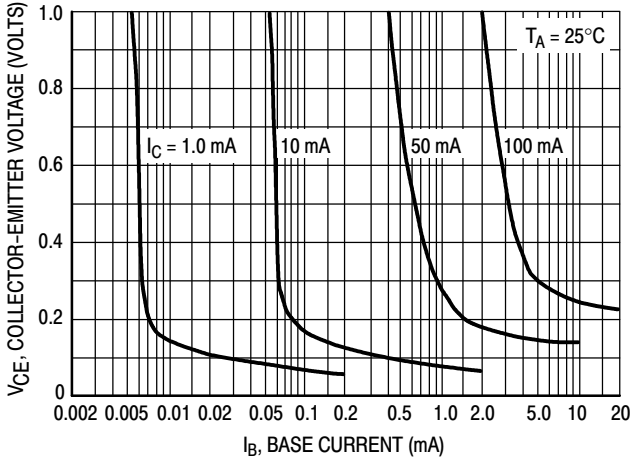

Figure 6. Collector Saturation Region

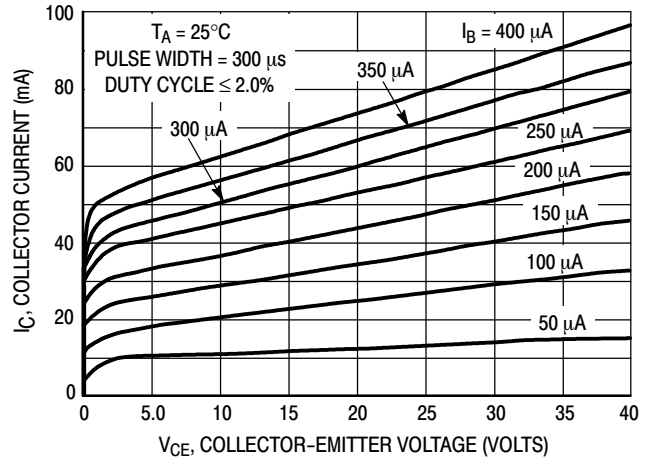

Figure 7. Collector Characteristics

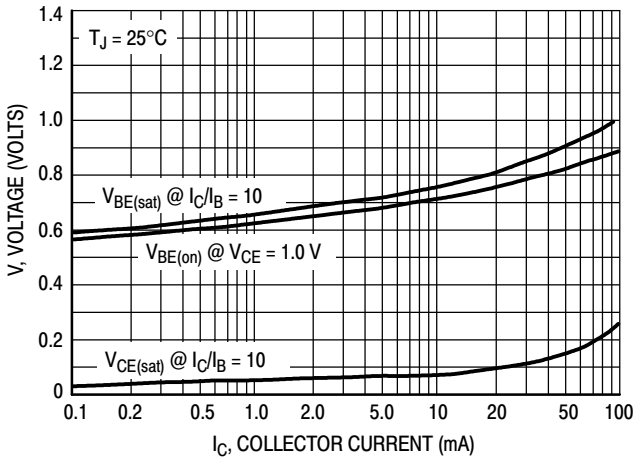

Figure 8. "On" Voltages

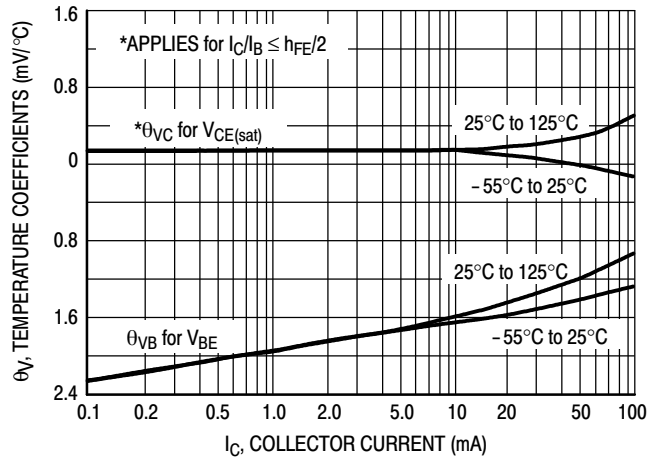

Figure 9. Temperature Coefficients

MMBT5087LT1G

TYPICAL DYNAMIC CHARACTERISTICS

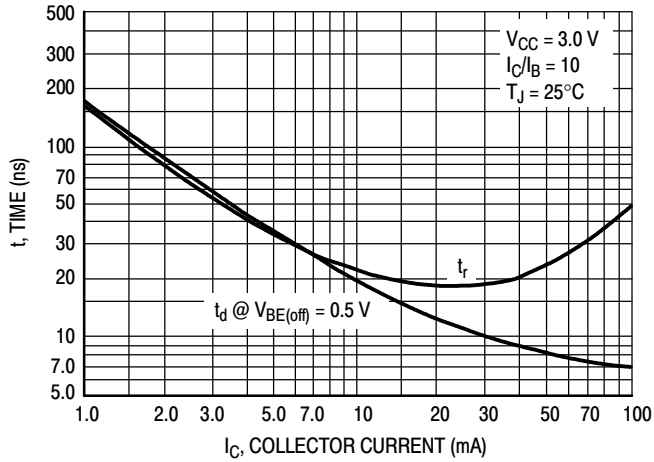

Figure 10. Turn-On Time

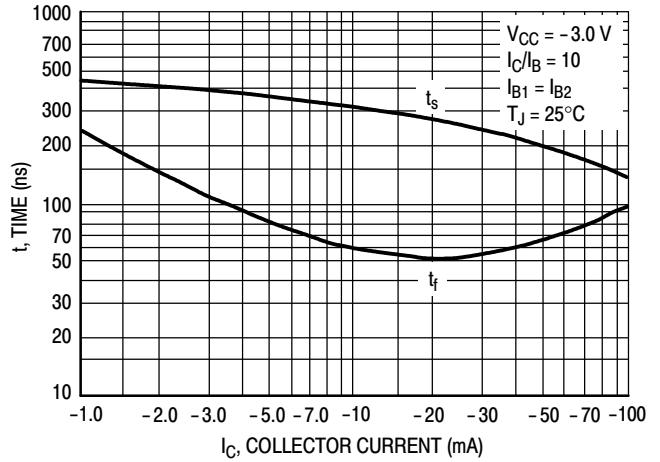

Figure 11. Turn-Off Time

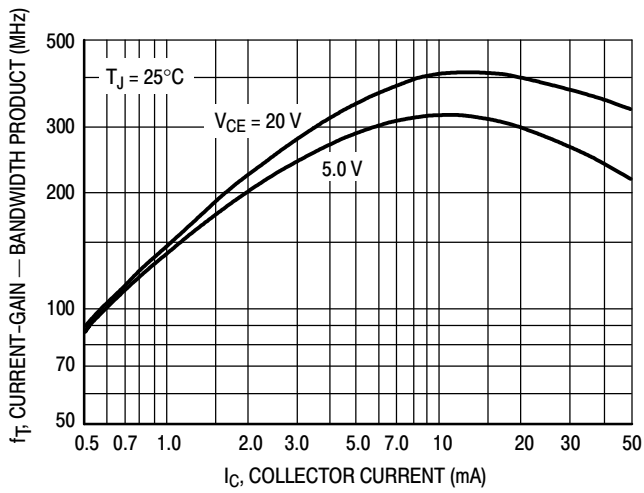

Figure 12. Current-Gain — Bandwidth Product

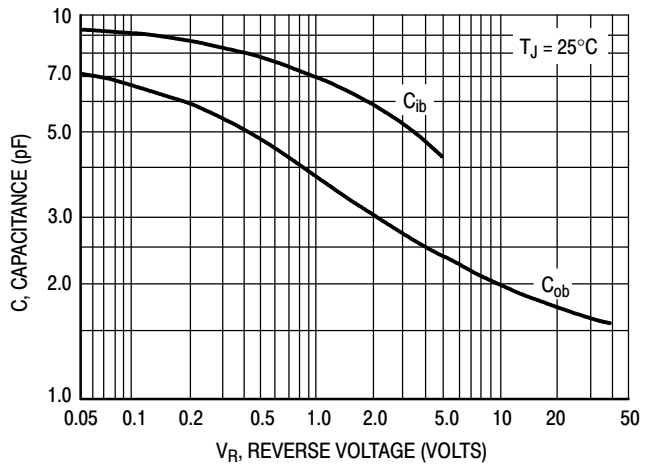

Figure 13. Capacitance

MMBT5087LT1G

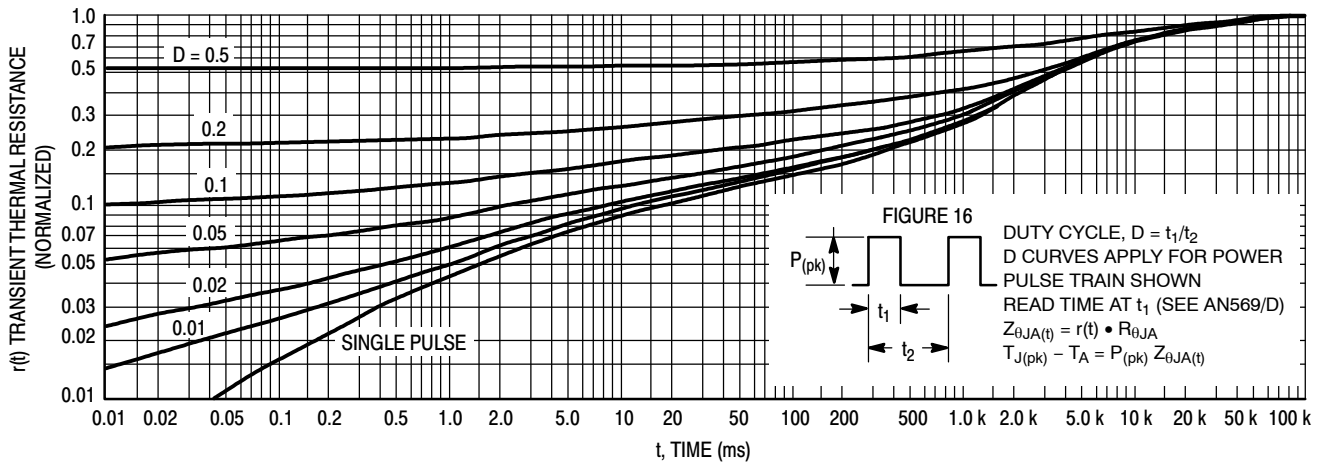

Figure 14. Thermal Response

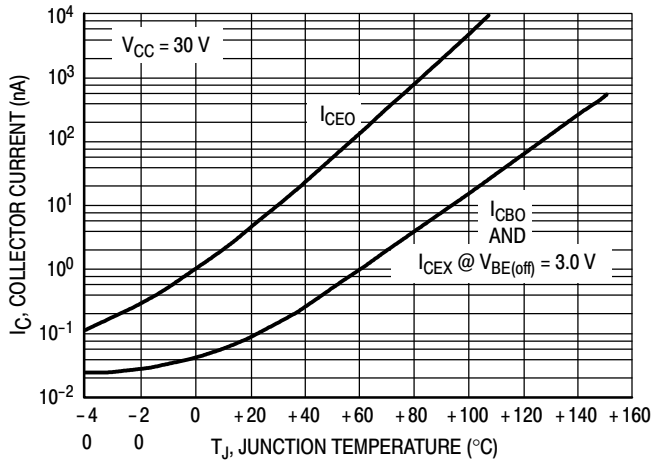

Figure 15. Typical Collector Leakage Current

DESIGN NOTE: USE OF THERMAL RESPONSE DATA

A train of periodical power pulses can be represented by the model as shown in Figure 16. Using the model and the device thermal response the normalized effective transient thermal resistance of Figure 14 was calculated for various duty cycles.

To find $Z_{\theta JA(t)}$, multiply the value obtained from Figure 14 by the steady state value $R_{\theta JA}$.

Example:

Dissipating 2.0 watts peak under the following conditions:

$$t_1 = 1.0 \text{ ms}, t_2 = 5.0 \text{ ms} (D = 0.2)$$

Using Figure 14 at a pulse width of 1.0 ms and $D = 0.2$, the reading of $r(t)$ is 0.22.

The peak rise in junction temperature is therefore

$$\Delta T = r(t) \times P_{(pk)} \times R_{\theta JA} = 0.22 \times 2.0 \times 200 = 88^\circ\text{C}.$$

For more information, see ON Semiconductor Application Note AN569/D, available from the Literature Distribution Center or on our website at www.onsemi.com.

MMBT5087LT1G

PACKAGE DIMENSIONS

SOT-23 (TO-236)
CASE 318-08
ISSUE AN

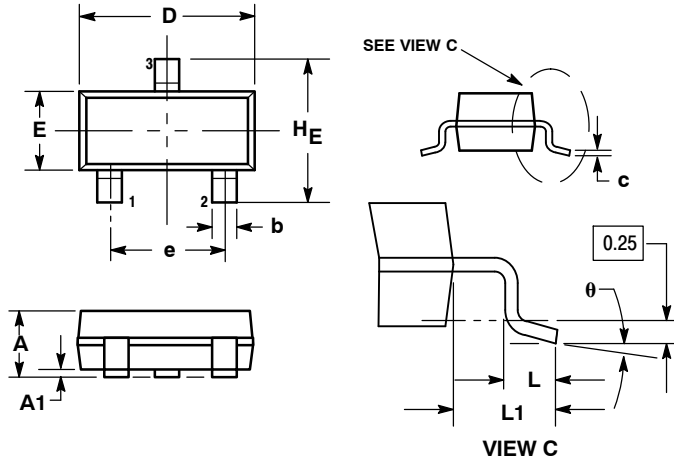

NOTES:

1. DIMENSIONING AND TOLERANCING PER ANSI Y14.5M, 1982.
2. CONTROLLING DIMENSION: INCH.
3. MAXIMUM LEAD THICKNESS INCLUDES LEAD FINISH THICKNESS. MINIMUM LEAD THICKNESS IS THE MINIMUM THICKNESS OF BASE MATERIAL.
4. 318-01 THRU -07 AND -09 OBSOLETE, NEW STANDARD 318-08.

DIM	MILLIMETERS			INCHES		
	MIN	NOM	MAX	MIN	NOM	MAX
A	0.89	1.00	1.11	0.035	0.040	0.044
A1	0.01	0.06	0.10	0.001	0.002	0.004
b	0.37	0.44	0.50	0.015	0.018	0.020
c	0.09	0.13	0.18	0.003	0.005	0.007
D	2.80	2.90	3.04	0.110	0.114	0.120
E	1.20	1.30	1.40	0.047	0.051	0.055
e	1.78	1.90	2.04	0.070	0.075	0.081
L	0.10	0.20	0.30	0.004	0.008	0.012
L1	0.35	0.54	0.69	0.014	0.021	0.029
HE	2.10	2.40	2.64	0.083	0.094	0.104

STYLE 6:

1. BASE
2. EMITTER
3. COLLECTOR

SOLDERING FOOTPRINT*

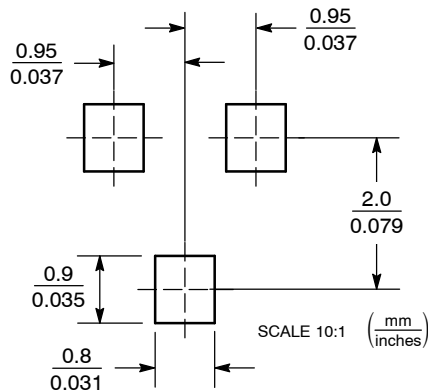

*For additional information on our Pb-Free strategy and soldering details, please download the ON Semiconductor Soldering and Mounting Techniques Reference Manual, SOLDERRM/D.

ON Semiconductor and are registered trademarks of Semiconductor Components Industries, LLC (SCILLC). SCILLC reserves the right to make changes without further notice to any products herein. SCILLC makes no warranty, representation or guarantee regarding the suitability of its products for any particular purpose, nor does SCILLC assume any liability arising out of the application or use of any product or circuit, and specifically disclaims any and all liability, including without limitation special, consequential or incidental damages. "Typical" parameters which may be provided in SCILLC data sheets and/or specifications can and do vary in different applications and actual performance may vary over time. All operating parameters, including "Typicals" must be validated for each customer application by customer's technical experts. SCILLC does not convey any license under its patent rights nor the rights of others. SCILLC products are not designed, intended, or authorized for use as components in systems intended for surgical implant into the body, or other applications intended to support or sustain life, or for any other application in which the failure of the SCILLC product could create a situation where personal injury or death may occur. Should Buyer purchase or use SCILLC products for any such unintended or unauthorized application, Buyer shall indemnify and hold SCILLC and its officers, employees, subsidiaries, affiliates, and distributors harmless against all claims, costs, damages, and expenses, and reasonable attorney fees arising out of, directly or indirectly, any claim of personal injury or death associated with such unintended or unauthorized use, even if such claim alleges that SCILLC was negligent regarding the design or manufacture of the part. SCILLC is an Equal Opportunity/Affirmative Action Employer. This literature is subject to all applicable copyright laws and is not for resale in any manner.

PUBLICATION ORDERING INFORMATION

LITERATURE FULFILLMENT:

Literature Distribution Center for ON Semiconductor
P.O. Box 5163, Denver, Colorado 80217 USA
Phone: 303-675-2175 or 800-344-3860 Toll Free USA/Canada
Fax: 303-675-2176 or 800-344-3867 Toll Free USA/Canada
Email: orderlit@onsemi.com

N. American Technical Support: 800-282-9855 Toll Free
USA/Canada
Europe, Middle East and Africa Technical Support:
Phone: 421 33 790 2910
Japan Customer Focus Center
Phone: 81-3-5773-3850

ON Semiconductor Website: www.onsemi.com

Order Literature: <http://www.onsemi.com/orderlit>

For additional information, please contact your local Sales Representative